

# RESMED

Log on now to [www.myresmed.com](http://www.myresmed.com)  
to find useful tips on managing your treatment.

## Mirage Kidsta™ Nasal Mask

Reorder No. 61802/3 2012-06

USER'S GUIDE

English



**Note:** For complete instructions, read the text section in conjunction with the illustrations on this sheet. /  
**Nota:** Para instrucciones detalladas, sírvase leer el texto en conjunto con las ilustraciones de esta hoja.

# A

## Pressure-Flow Curve / Curva de Presión-Flujo

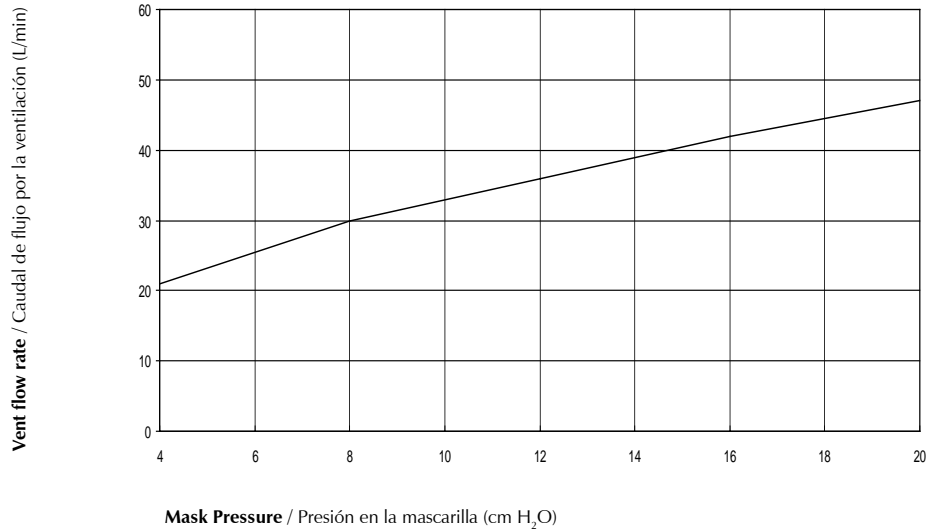

© 2012 ResMed Ltd.

# B

## Mask Parts / Piezas de la mascarilla

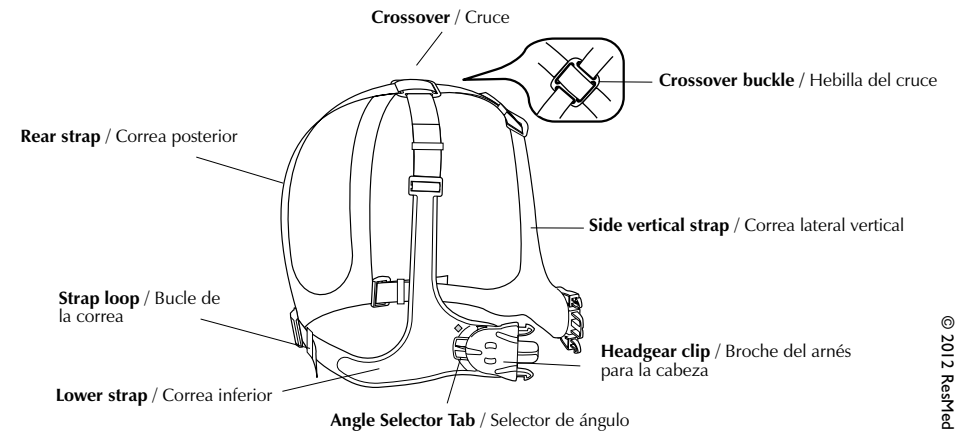
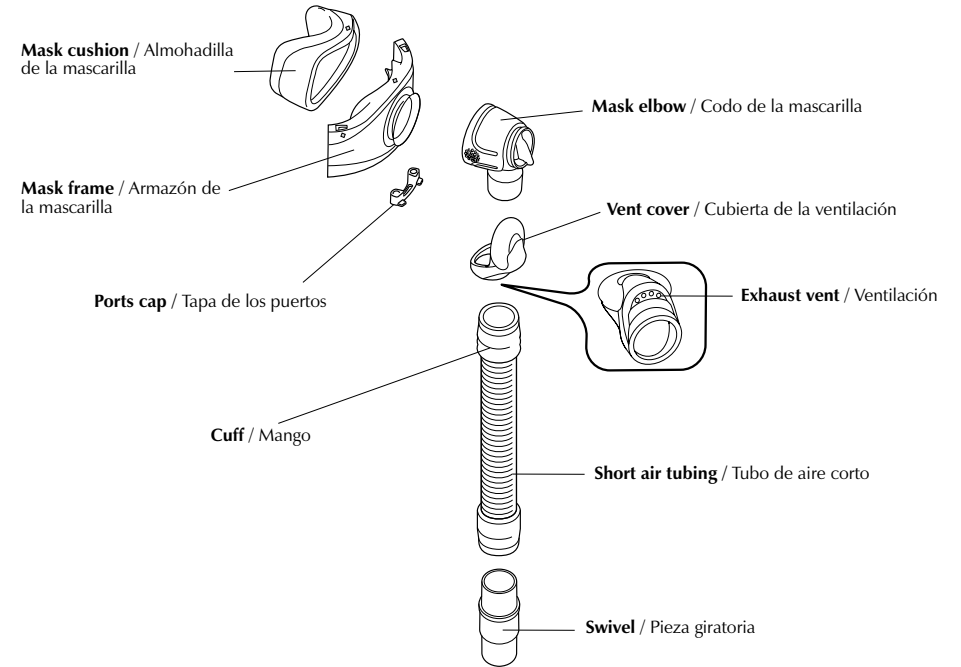

© 2012 ResMed Ltd.

# C Fitting / Colocación

C-1

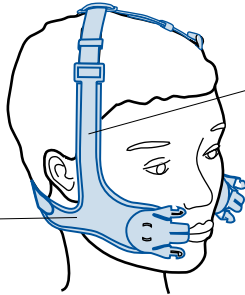

Side strap is vertical / La correa lateral es vertical

Lower strap sits below ear / La correa inferior se apoya detrás de la oreja

C-2

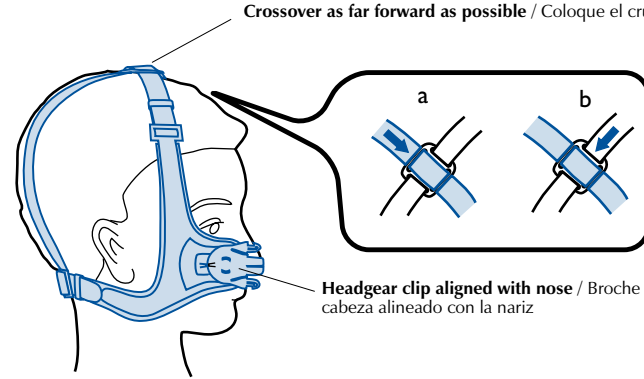

Crossover as far forward as possible / Coloque el cruce lo más hacia delante posible

Headgear clip aligned with nose / Broche del arnés para la cabeza alineado con la nariz

C-3

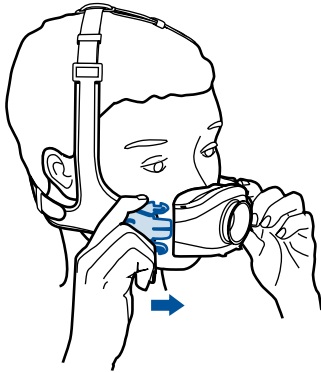

C-4

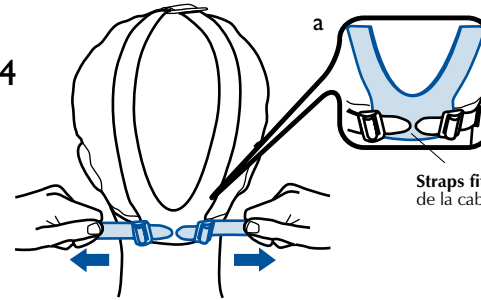

Straps fit securely at base of head / Las correas se ajustan en la base de la cabeza

C-5

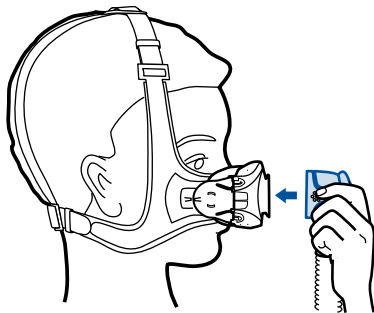

C-6

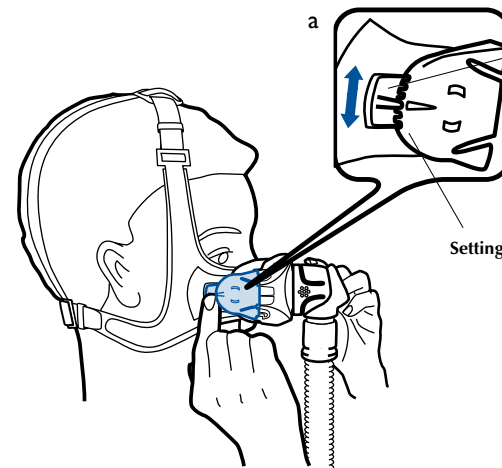

Angle Selector Tab / Lengüeta selectora de ángulo

Settings / Posiciones

# D

## Disassembling / Desmontaje

D-1

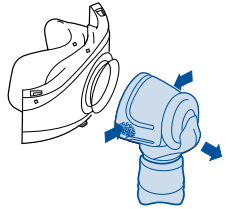

D-2

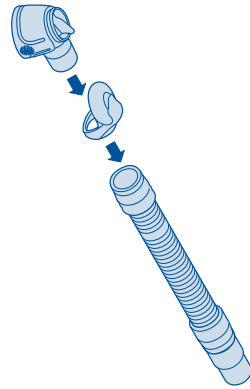

D-3

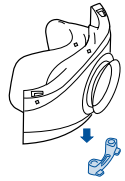

D-4

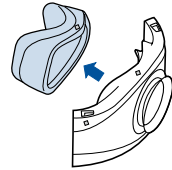

© 2012 ResMed Ltd.

# E

## Reassembling / Montaje

E-1

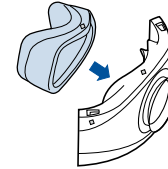

E-2

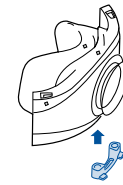

E-3



E-4

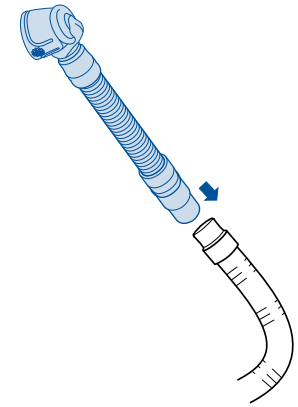

© 2012 ResMed Ltd.

**Note:** The headgear does not need to be disassembled for cleaning. Headgear reassembly instructions are provided here as additional information. /  
**Nota:** El arnés no necesita ser desmontado para su limpieza. Las instrucciones para volver a montar el arnés se proporcionan aquí únicamente como información adicional.

F-1

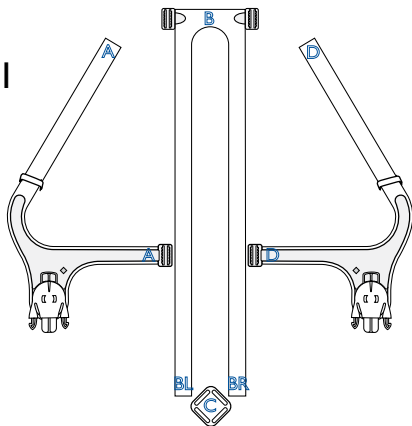

F-2

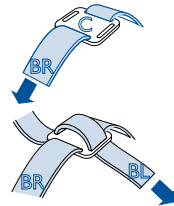

F-3

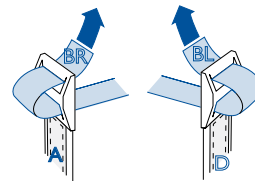

F-4

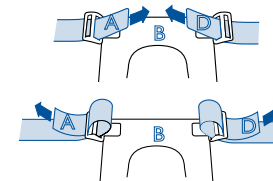

F-5

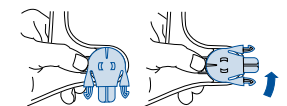

© 2012 ResMed Ltd.

## Mirage Kidsta™ Nasal Mask

The MIRAGE KIDSTA™ NASAL MASK is intended for multipatient use for children aged seven and older or weighing more than 40 lb, prescribed continuous positive airway pressure (CPAP) or bilevel therapy in hospital, clinic and/or home environments. The MIRAGE KIDSTA NASAL MASK is intended to be used with ResMed's VPAP III ST-A.

### CAUTION

**In the USA, federal law restricts this device to sale by, or on the order of, a physician.**

### MEDICAL INFORMATION

**Note:** *The mask system does not contain latex materials. If you have ANY reaction to any part of the mask system, discontinue use and consult your sleep therapist.*

### WARNINGS AND CAUTIONS

- Your physician should determine the degree of arousability before commencing CPAP treatment. Use of secondary sensing devices such as apnea monitors and transcutaneous carbon dioxide monitors is advisable. These will help determine whether nasal CPAP treatment should be applied.

- Children who are unable to remove the mask should be attended at all times during therapy.
- Ensure that the nasal cushion does not block the nostrils at any time during fitting or use.
- The MIRAGE KIDSTA is designed to provide a stable, effective air seal with minimum headgear tension. High headgear tension may lead to facial deformities with long-term use. Regular clinician review of growth patterns and the use of different styles of mask is recommended.
- The mask contains small parts which could result in a choking risk. Your clinician should assess the suitability of the selected mask.
- This mask should be used only with flow generators recommended by your physician or respiratory therapist. A mask should not be used unless the flow generator is turned on and operating properly. The exhaust vent should never be blocked.
 

**Explanation of the Warning:** Flow generators are intended to be used with special masks with connectors which may have vent holes or separate exhaust vents to allow continuous flow of air out of the mask. When the flow generator is turned on and functioning properly, new air from the flow

generator flushes the exhaled air out through the attached mask exhaust vent. However, when the flow generator is not operating, enough fresh air will not be provided through the mask, and exhaled air may be rebreathed. Rebreathing of exhaled air for longer than several minutes can in some circumstances lead to suffocation. This warning applies to most models of flow generators.

- At low CPAP pressures, the flow through the exhaust vent may be inadequate to clear all exhaled gas from the tubing. Some rebreathing may occur.

**Explanation of the Warning:** The exhaust vent flow is lower at lower mask pressures (see Pressure/Flow curve—**Figure A**). To avoid rebreathing it is recommended that a mask pressure of 4 cm H<sub>2</sub>O or more be used.

- The **MIRAGE KIDSTA** features an elbow that can be easily removed while the mask is fitted. The mask should not be used with the elbow attached unless the flow generator is turned on and operating properly.
- If oxygen is used with the flow generator, the oxygen flow must be turned off when the flow generator is not operating.

**Explanation of the Warning:** When the flow generator is not in operation, and the oxygen flow is left on, oxygen delivered into the ventilator tubing may accumulate within the flow generator enclosure. Oxygen accumulated in the flow generator will create a risk of fire. This warning applies to most types of flow generators.

- Please refrain from smoking while oxygen is in use.
- Using a mask may cause tooth, gum or jaw soreness or aggravate an existing dental condition. If symptoms occur, consult your physician or dentist.

**Note:** *At a fixed rate of supplemental oxygen flow, the inhaled oxygen concentration will vary, depending on the pressure settings, patient breathing pattern, mask selection and leak rate.*

## PARTS OF THE MASK

See **Figure B**.

## FITTING THE MASK

See **Figure C**.

**Note:** *Before fitting the mask, refer to the section “Cleaning the Mask in the Home”.*

- 1 Place the headgear on the head. Adjust the side vertical straps so that the lower strap sits just below the ear (not touching it) and at the base of the head (**Fig. C-1**).
- 2 The headgear clip should be parallel with the nose and not in the line of vision. Check that the crossover is as far forward as possible (**Fig. C-2**).  
To adjust the crossover to a forward position, slide the crossover buckle along one strap (**Fig. C-2a**) and then along the other strap (**Fig. C-2b**). Alternate the movement on each side until the crossover is as far forward as possible.
- 3 Ensure that the crossover and the rear straps lie flat against the head.
- 4 Place the mask on the nose (**Fig. C-3**). Clip the mask to the headgear.

- 5 Adjust the lower straps by pulling firmly (**Fig. C-4**) so that the rear straps fit securely around the base of the head (**Fig. C-4a**).

**Note:** Ensure that the nostrils are not blocked by the cushion.

- 6 Connect one end of the main air tubing to your flow generator and the other end to the swivel.

**Note:** The swivel, short air tubing and mask elbow are supplied assembled.

- 7 Turn your flow generator on.

- 8 Connect the mask elbow to the mask frame. To do this, hold the sides of the mask elbow (**Fig. C-5**) and firmly push the elbow onto the mask frame until it clicks into place.

Check that you have connected the mask elbow correctly by rotating it. Be careful not to squeeze the sides of the elbow. If the mask elbow is fitted correctly, it should rotate freely and not separate from the mask frame.

- 9 Adjust the angle of the mask by selecting the setting that provides a comfortable fit with minimum or no leak. To test each setting, hold down the Angle Selector Tab (**Fig. C-6**) and move the headgear clip up or down (**Fig. C-6a**) as required. You may need to raise the headgear clip when moving it from one setting to the next. The mask can be tilted at five different positions. If you feel excessive pressure on the middle of the nose, tilt the mask down. Alternatively, if you feel excessive pressure on your upper lip, tilt the mask up.

- 10 If you feel air leaks around the cushion, reposition the mask on your face to achieve a better seal.

Take time to adjust all straps and the position of the mask so that you can achieve a secure and comfortable fit.

### Notes:

- If you are unable to resolve any leaks you may need to try another cushion size.
- Excess headgear length may be trimmed to a suitable length if required. Leave at least 30 mm free length on the straps.
- Select “Standard” as the mask option when using the Mirage Kidsta with ResMed’s VPAP III ST-A.

## REMOVING THE MASK

To remove the MIRAGE KIDSTA, squeeze one of the headgear clips. This releases one side of the headgear from the mask. Pull the mask and headgear away from your head.

### Notes:

- Do not pull the headgear off your head without releasing the headgear clips first.
- You can detach the elbow from the mask frame while wearing the mask. This is useful when therapy needs to be stopped for a short time; for example if you need to go to the bathroom.
- Check that you can remove the headgear clip, the quick release swivel or the headgear unaided.

## DISASSEMBLING FOR CLEANING

See **Figure D**.

- 1 Detach the mask elbow. To do this, squeeze the sides of the mask elbow at the finger grips while pulling it away from the mask frame (**Fig. D-1**).
- 2 Disconnect and separate the main air tubing, short air tubing, mask elbow and vent cover (**Fig. D-2**).

**Notes:**

- To prevent damage to the short air tubing, disconnect it by holding it at the cuff.
  - The swivel does not need to be disconnected from the short air tubing.
- 3 Detach the headgear from the mask frame by squeezing and releasing both headgear clips.
  - 4 Remove the ports cap from the mask frame (**Fig. D-3**).
  - 5 Firmly pull the mask cushion away from the mask frame (**Fig. D-4**).

**CLEANING THE MASK IN THE HOME****Notes:**

- Wash the headgear before first time use, as the dye may run. It is important to always handwash the headgear.
- The headgear may be washed without being disassembled.

**DAILY/AFTER EACH USE**

Handwash the mask components in lukewarm, soapy water. Use pure soap (an example of pure soap is Dove® soap, unscented; made by Unilever). Rinse the components well and allow them to air dry out of direct sunlight.

**WEEKLY**

Handwash the headgear in warm, soapy water. Use pure soap. Rinse well and allow it to air dry out of direct sunlight.

**CAUTIONS**

- Do not use solutions containing bleach, chlorine, alcohol, aromatics, moisturisers, antibacterial agents, or scented oils to clean any part of the

mask system or air tubing. These solutions may cause damage and reduce the life of the product.

- Do not expose any part of the mask system or tubing to direct sunlight as it may deteriorate.
- If any visible deterioration of a mask component is apparent (cracking, crazing, tears etc.), the mask component should be discarded and replaced.

**CLEANING THE MASK BETWEEN PATIENTS**

The mask system (excluding the swivel and short tube) is validated for multipatient use. Cleaning, disinfection and sterilization instructions are available from the ResMed website, [www.resmed.com/masks/sterilization/americas](http://www.resmed.com/masks/sterilization/americas).

If you do not have Internet access, please contact your ResMed representative.

To clean the headgear between patients, use the method described in the previous section "Cleaning the Mask in the Home".

**REASSEMBLING THE MASK**

See **Figure E**.

- 1 Insert the mask cushion into the groove of the mask frame (**Fig. E-1**). Fit the top section first and then work your way around, pushing the mask cushion into the mask frame.

**Note:** The diamond markers on the mask frame and on the mask cushion (one on top, two at the bottom) must line up.

- 2 Push the ports cap onto the mask ports (**Fig. E-2**).
- 3 Attach the vent cover to the mask elbow. To do this, insert the elbow into the ring of the vent cover (**Fig. E-3**). Push the ring to the top so that the vent



cover is over the back of the elbow. Then, press the lip of the vent cover to ensure that it is securely seated in the groove of the elbow.

- 4 Connect the short air tubing to the mask elbow.
- 5 Connect the swivel to the main air tubing, ready for next use (**Fig. E-4**).

## ADDITIONAL INFORMATION

### REASSEMBLING THE HEADGEAR

**Note:** *You do not need to disassemble the headgear for cleaning. However, if you choose to do so, the reassembly procedure is explained in this section.*

When disassembled, the headgear has four parts:

A: Left strap, B: Middle strap,

C: Crossover buckle, D: Right strap

- 1 Lay out the four parts of the headgear as shown in **Figure F-1**.
- 2 As shown in **Figure F-2**, thread the straps BR and BL through the crossover buckle (Part C).
- 3 Thread strap BR through the buckle on Part A. Thread strap BL through the buckle on Part D (**Fig. F-3**).
- 4 Thread the straps of Part A and Part D through the buckles on Part B (**Fig. F-4**).
- 5 With the headgear clip facing down, fit the headgear clip onto the hole on the headgear. While pressing the headgear tab down, rotate the headgear clip away from the tab to lock it into place (**Fig. F-5**). Repeat this with the other headgear clip.

## TECHNICAL SPECIFICATIONS

### PRESSURE–FLOW CURVE

See **Figure A**.

### DEAD SPACE INFORMATION

Dead space is the empty volume of the mask up to the swivel.

The dead space of the mask for all cushion sizes is 81 mL.

## REPLACEMENT PARTS

Part No.	Item
61020	Headgear Assembly, Small
60013	Cushion, Small
61025	Headgear clip - blue (2 pk.)
61026	Headgear clip - blue (10 pk.)
60023	Crossover buckle - blue
60024	Crossover buckle - blue (10 pk.)
60924	Mask Frame
60925	Elbow Assembly
60014	Swivel Assembly (10 pk.)
60926	Inlet Tube and Swivel Assembly
60927	Inlet Tube and Swivel Assembly (10 pk.)
16570	Ports cap (2 pk.)
16571	Ports cap (10 pk.)
61010	Mask System, Small

## LIMITED WARRANTY

ResMed warrants that your ResMed mask system, including its components: mask frame, cushion, headgear, tubing and other accessories ("Product") shall be free from defects in material and workmanship for a period of ninety (90) days from the date of purchase by the initial consumer.

For further details refer to the Warranty.

---

**Note:** *Translations are based on the English version in this guide. However, there may be minor variations based on the disinfection/sterilization procedures applicable in some countries. ResMed has reviewed these changes and all procedures included here have been validated.*



**Manufacturer:**

ResMed Ltd 1 Elizabeth Macarthur Drive Bella Vista NSW 2153 Australia

**Distributed by:**

ResMed Corp 9001 Spectrum Center Boulevard San Diego CA 92123 USA

ResMed (UK) Ltd 96 Milton Park Abingdon Oxfordshire OX14 4RY UK

See [www.resmed.com](http://www.resmed.com) for other ResMed locations worldwide.



For patent information, see [www.resmed.com/ip](http://www.resmed.com/ip).

M sage and Kidsta are trademarks of ResMed Ltd and are registered in U.S. Patent and Trademark Office.

Dove is a registered trademark of Unilever.

© 2012 ResMed Ltd.



61802